

**GABINETE**  
**TR 600 - 12"**

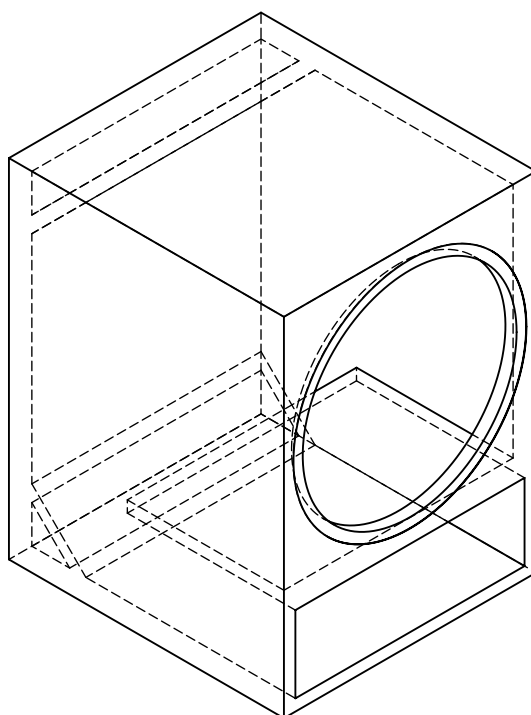
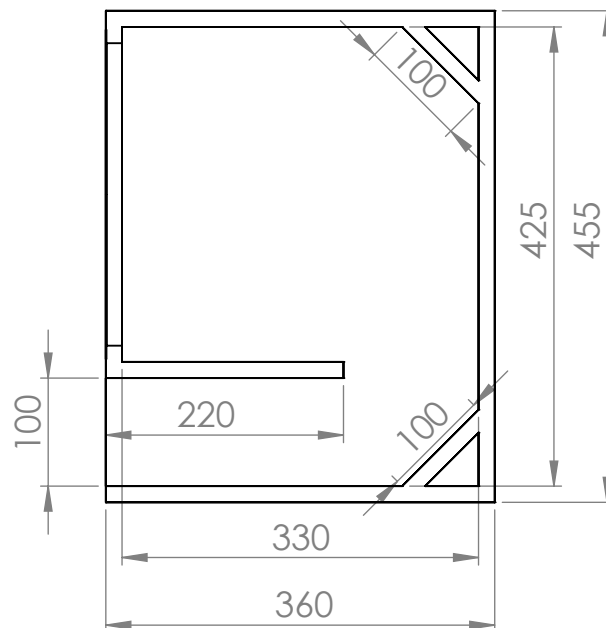
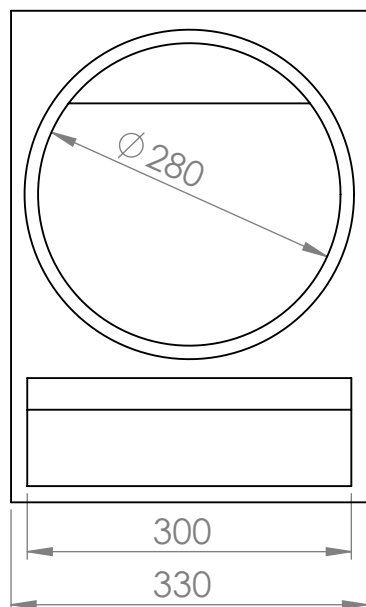

Material: Madeira 15mm  
Vol. Box : 42 Litros  
Sintonia do Box: 80 Hz

**CROSSOVER**  
HPF: 75 @ 24 dB/8ª  
LPF: 400 @ 24 dB/8ª

TRITON - INDÚSTRIA E COMÉRCIO ALTO-FALANTES LTDA  
Av. Afílio Albertini, 1460, Distrito Industrial, Regente Feijó - SP  
CEP: 19570-000 / Tel: +55 (18) 3279-9100

Rev: 10/01/20  
Especificações sujeita a alterações sem aviso prévio

[www.tritonaltofalantes.com.br](http://www.tritonaltofalantes.com.br)  
[suporte@tritonaltofalantes.com.br](mailto:suporte@tritonaltofalantes.com.br)