

GABINETE
MG 510 - 10"

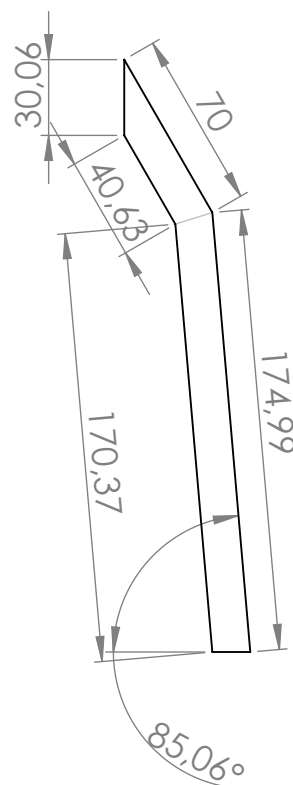
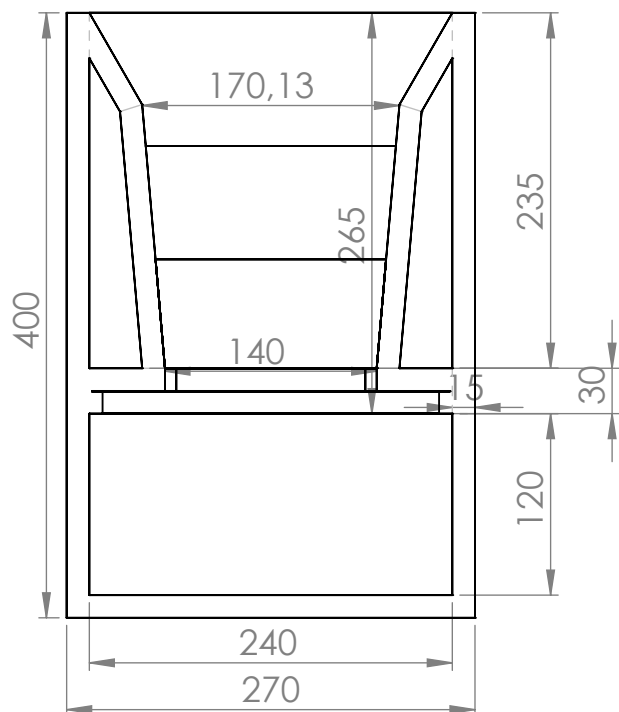
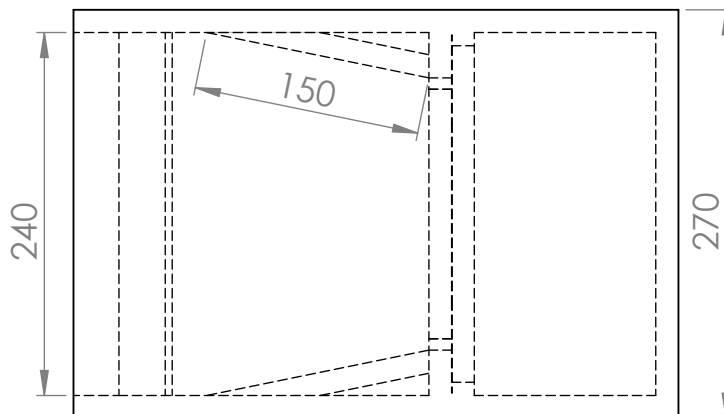
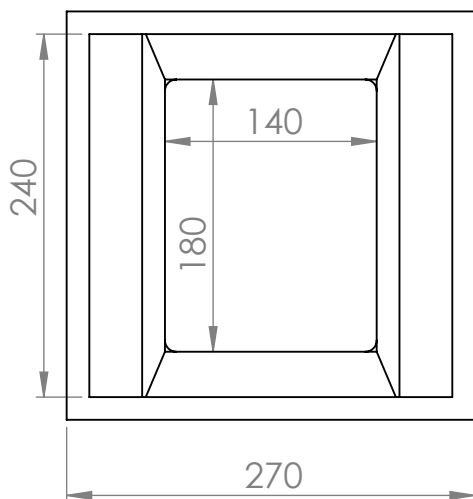

Material: Madeira 15mm
Vol. Box : 6,9 Litros
Sintonia do Box: Hz

CROSSOVER
HPF: 200 @ 24 dB/8ª
LPF: 1200 @ 24 dB/8ª

TRITON - INDÚSTRIA E COMÉRCIO ALTO-FALANTES LTDA
Av. Afílio Albertini, 1460, Distrito Industrial, Regente Feijó - SP
CEP: 19570-000 / Tel: +55 (18) 3279-9100

Rev: 10/01/20
Especificações sujeita a alterações sem aviso prévio

www.tritonaltofalantes.com.br
suporte@tritonaltofalantes.com.br

GABINETE
MG 510 - 10"

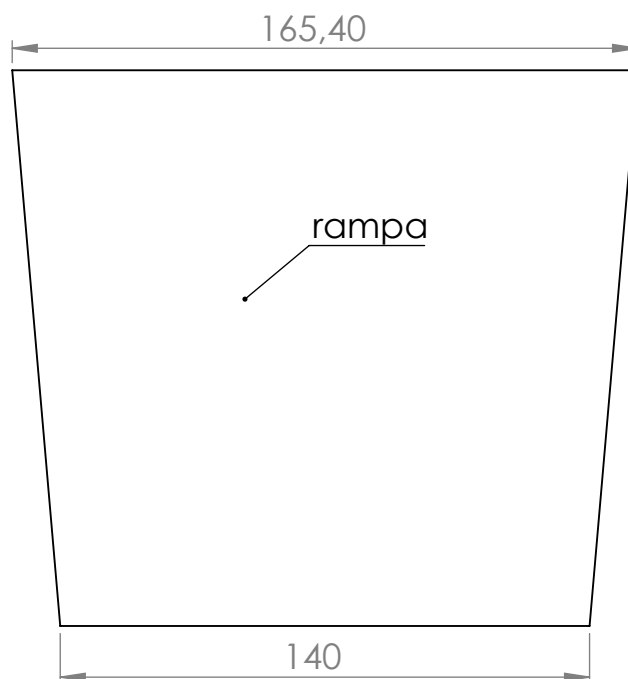
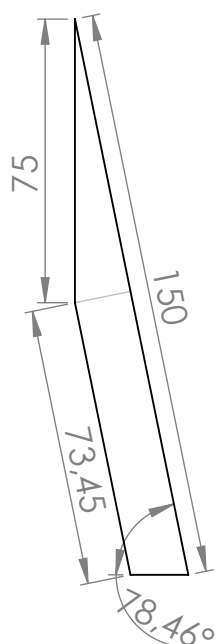
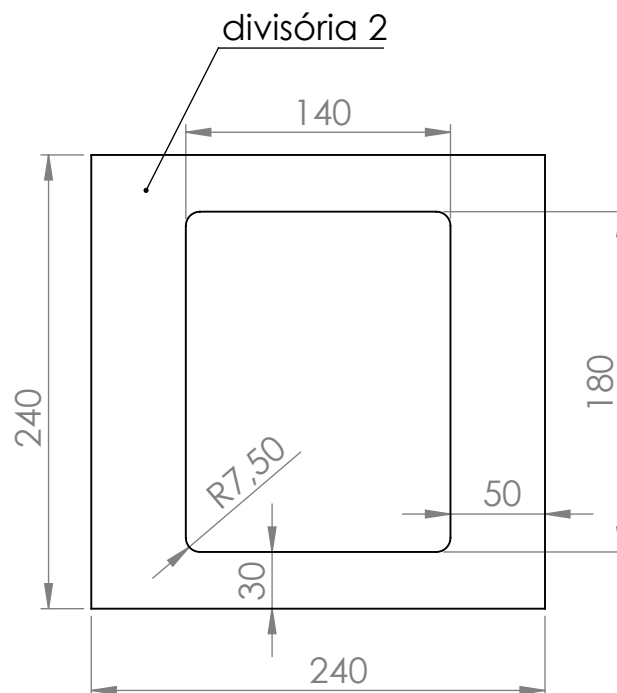
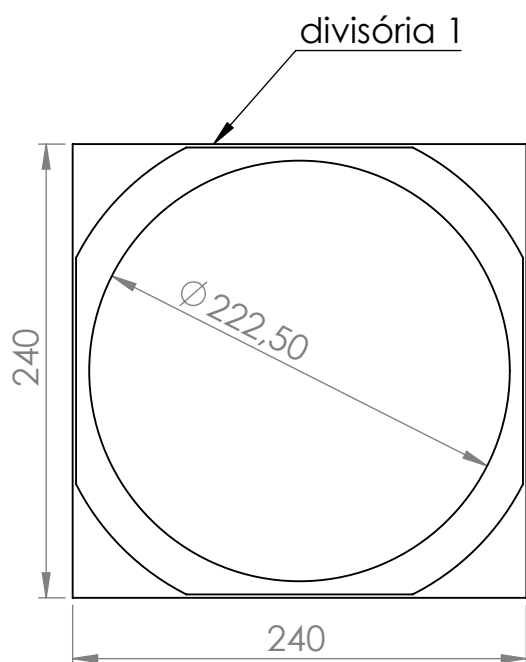

TRITON - INDÚSTRIA E COMÉRCIO ALTO-FALANTES LTDA
Av. Afílio Albertini, 1460, Distrito Industrial, Regente Feijó - SP
CEP: 19570-000 / Tel: +55 (18) 3279-9100